

SPARK SGN LED



IP40









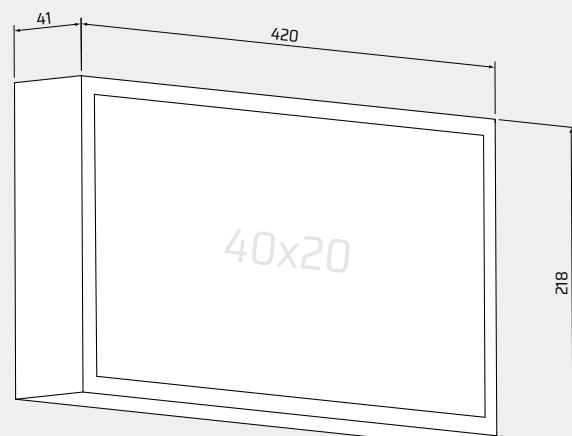
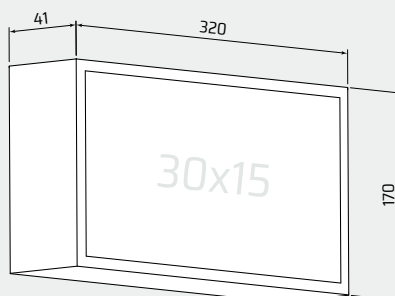





Havaintoetäisyys:

30x15cm  30m

40x20cm  40m



SAFETY SIGNS

P04		P118		PI25	
PI05		PI21		PI26	
PI06		PI22		PI27	
PI15		PI23			
PI17		PI24			

ORDERING

SPARK SGN LED 0000 - EN - SS - 30x15 - AT - 3h - 9003 - FT - W1 - X - PI21

Safety sign dimension:

30x15 - 30x15cm

40x20 - 40x20cm

System variant:

ST - standard

AT - autotest

CT - centraltest

CB - centrally supplied luminaire

CBAM - centrally supplied luminaire, with address module

LVAM - centrally low voltage supplied luminaire, with address module

Emergency operation time:

1h - emergency operation time of 60 minutes

3h - emergency operation time of 180 minutes

X - not applicable (CB, CBAM, LVAM)

Housing colours:

9003 -  RAL 9003

9006 -  RAL 9006

9005 -  RAL 9005

... - other on special order

Mounting types:

W1 - back to the wall

Safety sign:

NOP - plate without safety sign

... - see table „SAFETY SIGNS“

X - without PC plate (shade ordered separately)

Caution: The luminaire can not be mounted without a plate with safety sign